

---

**TOPMATIC 325B**

---

**POTAIN** 

# POTAIN TOPMATIC 325B

Cotes Abmessungen Dimensionen Dimensiones

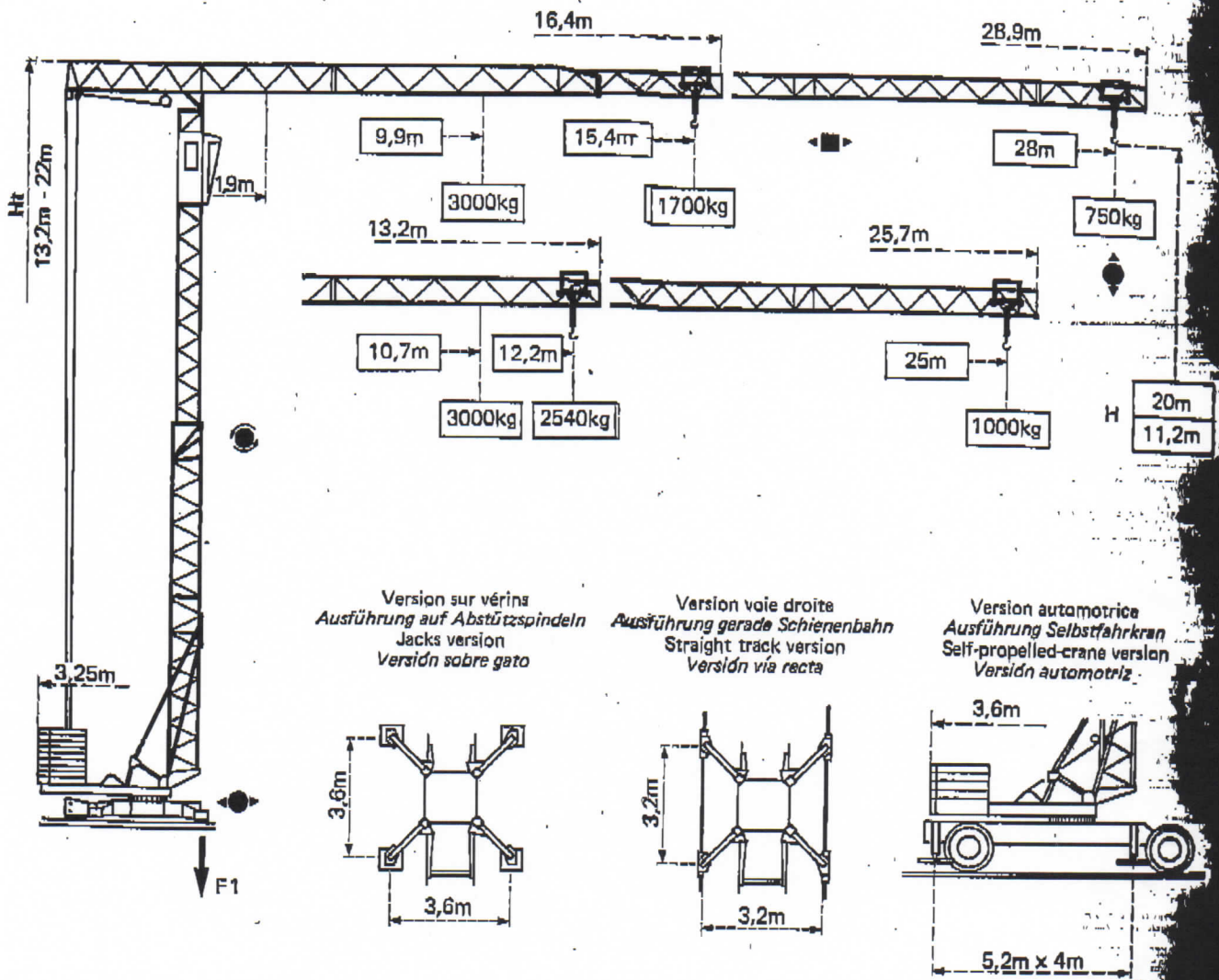

Version sur vérins  
Ausführung auf Abstützspindeln  
Jacks version  
Versión sobre gato

Version voie droite  
Ausführung gerade Schienenbahn  
Straight track version  
Versión vía recta

Version automotrice  
Ausführung Selbstfahrkran  
Self-propelled-crane version  
Versión automotriz

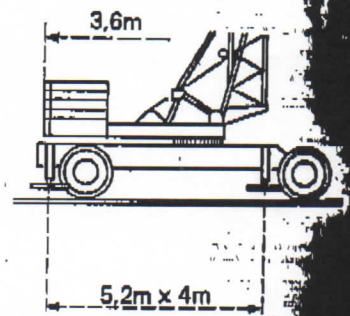
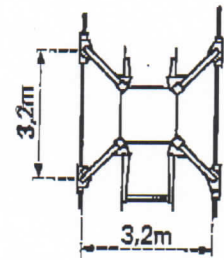
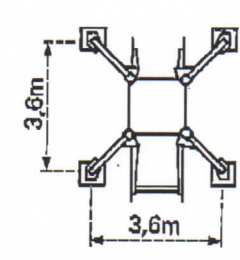

F1 = Réactions Eckdrücke Reactions Reacciones

F1	● 142kN	■ 89kN
F1	● 164kN	■ 92,5kN
	11t	

Version sur vérins Ausführung auf Abstützspindeln Jacks version Versión sobre gato

Version voie droite Ausführung gerade Schienenbahn Straight track version Versión vía recta

● En service  
■ Hors service

A vide sans lest ni train de transport, avec flèche et hauteur maximum.

● In Betrieb  
■ Ausser Betrieb

Ohne Last, Ballast und Transportachse, mit Maximalausleger und Maximalhöhe.

● In service  
■ Out of service

Without load, ballast or transport axles, with maximum jib and maximum height.

● En servicio  
■ Fuera de servicio

Sin carga, sin lastre, ni tren de transporte, flecha y altura máximas.

# Courbes de charges Lastkurven Load diagram Curvas de cargas

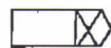

Flèche Ausleger Jib Flecha

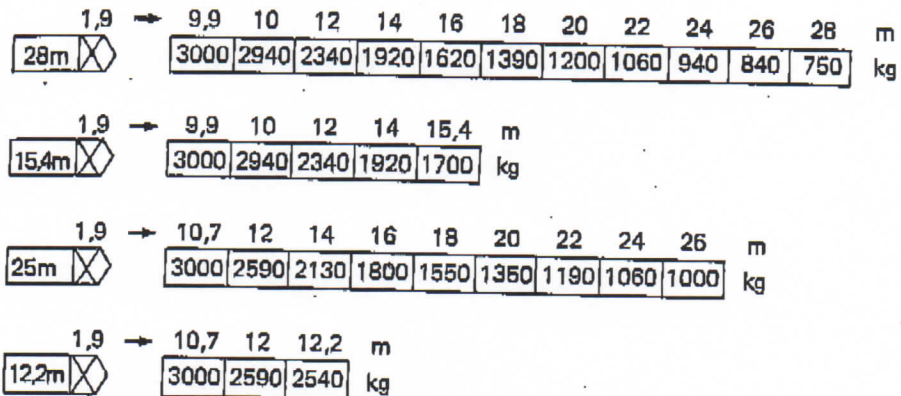

## Flèche relevée Ausleger in Steilstellung Luffing jib Flecha izada

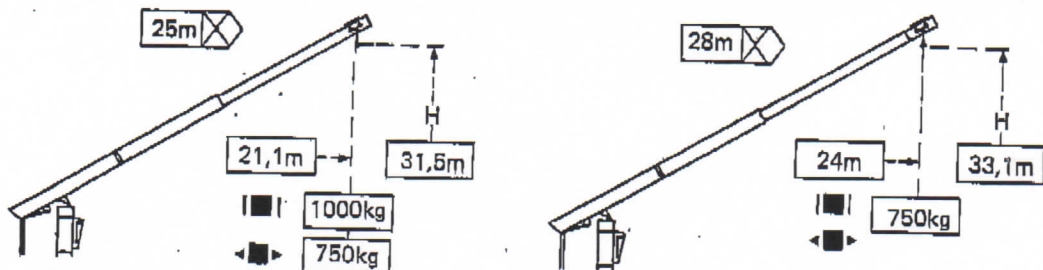

- Chariot bloqué (version standard) - Verriegelte Laufkatze (Standardausführung)  
Trolley locked (standard crane) - Carro bloqueado (versión standard)
- ◄ Chariot distributeur (option usine) - Verfahrbare Laufkatze (Sonderausführung ab Werk)  
Traversing trolley (plant option) - Carro distribuidor (opción de fábrica).

## Montage Montage Erection Montaje

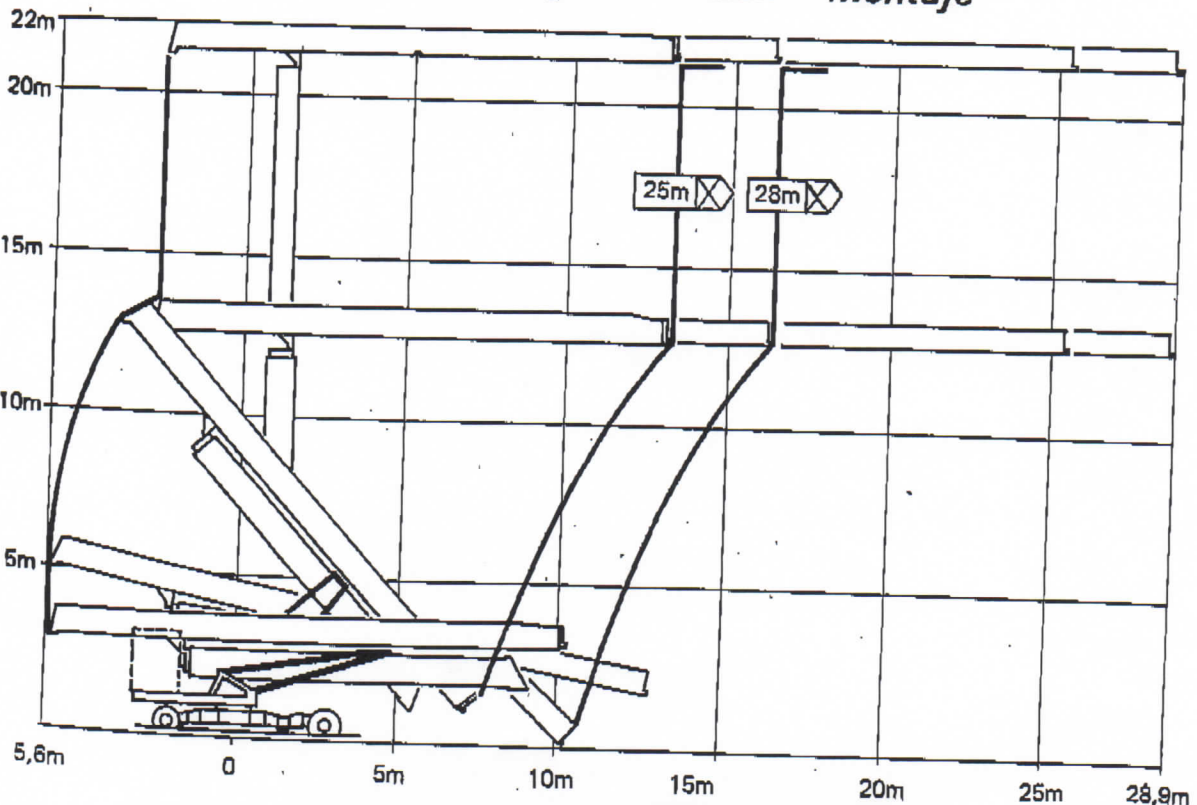



**SERVICE**



**VERMIETUNG**



**VERKAUF**



**Bau- und Industriekrane**  
**Schwertransporte**  
**Hydraulikservice**  
**LKW-Kranarbeit**  
**Arbeitsbühnen**  
**Teleskoplader**



Wahlenstrasse 175, 4242 Laufen



061 781 55 11



info@bischag.ch

