

MDT 192 H12

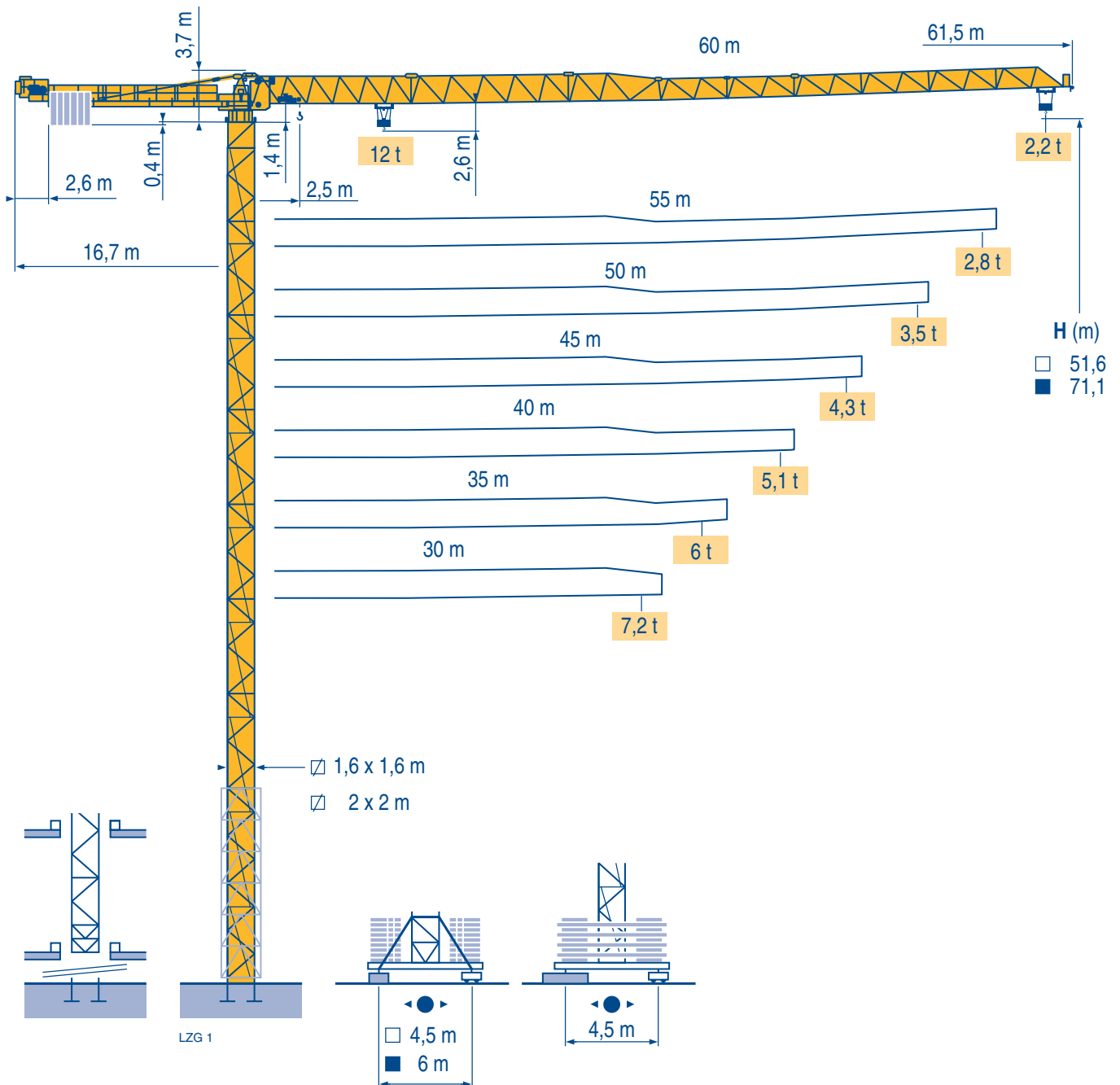

Topless

CE FEM 1.001-A3

Mat / Réactions \square 1,6 m

Maste / Eckdrücke \triangle
30 m \Rightarrow 60 m

Masts / Reactions

Mástil / Reacciones

Torre / Reazioni

Tramo / Reações

L26 1

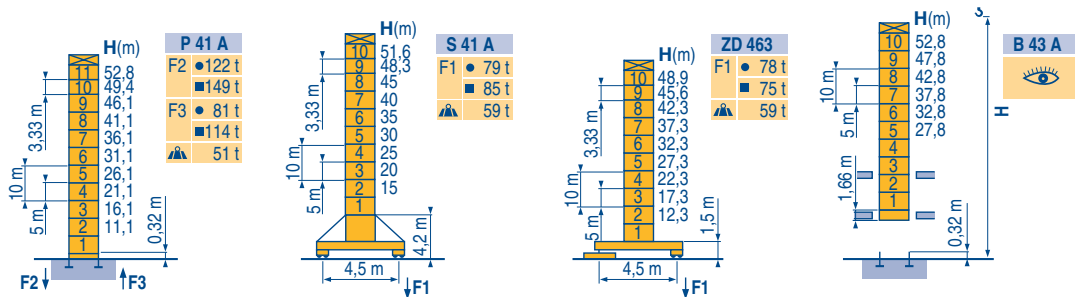

\square 2 m
30 m \Rightarrow 60 m

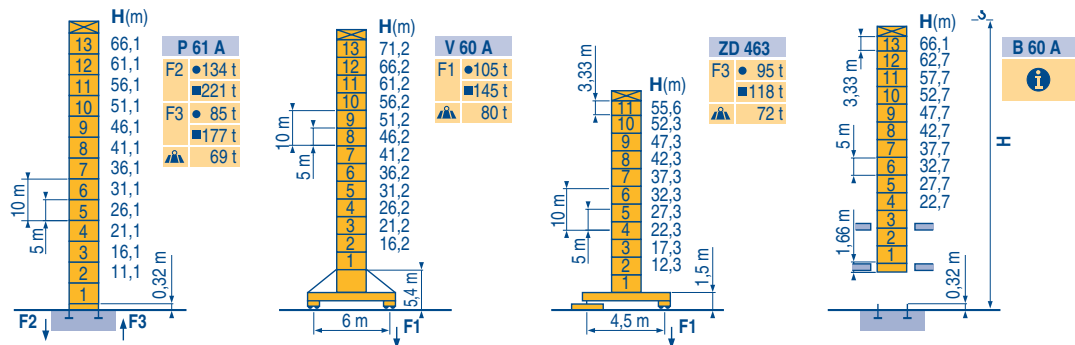

Téléscopage sur dalles
Kletterkrane im Gebäude
Climbing crane
Telescopage gruas trepadoras
Gru in cavedio
Telescopagem sobre lajes

L26 1

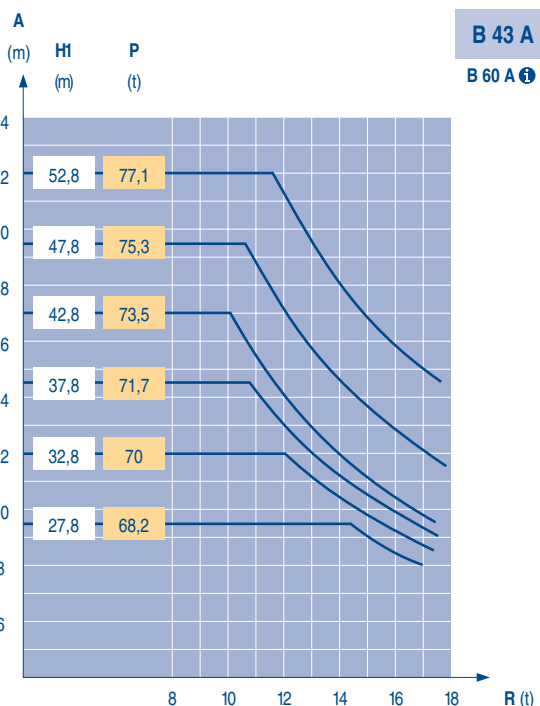
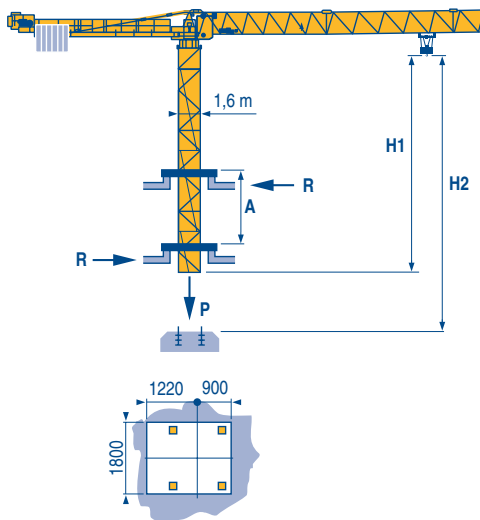

Topless
MDT 192 H12

POTAIN

F	D	GB	E	I	P
●	●	●	●	●	●
■	■	■	■	■	■
Reactions en service	Reaktionskräfte in Betrieb	Reactions in service	Reacciones en servicio	Reazioni in servizio	Reações em serviço
Reactions hors service	Reaktionskräfte außer Betrieb	Reactions out of service	Reacciones fuera de servicio	Reazioni fuori servizio	Reações fora de serviço
A vide sans lest (ni train de transport) avec flèche et hauteur maximum.	Ohne Last, Ballast (und Transportachse), mit Maximalausleger und Maximalhöhe.	Without load, ballast (or transport axes), with maximum jib and maximum height.	Sin carga, sin lastre, (ni tren de transporte), flecha y altura máxima.	A vuoto, senza zavorra (ne assali di trasporto) con braccio massimo e altezza massima.	Sem carga (nem trem de transporte)- sem lastro com lança e altura máximas.
Nous consulter	Auf Anfrage	Consult us	Consultarnos	Consultateci	Consultar-nos

Courbes de charges
Lastkurven
Load diagrams
Curvas de cargas
Curve di carico
Curva de cargas

LZG 1

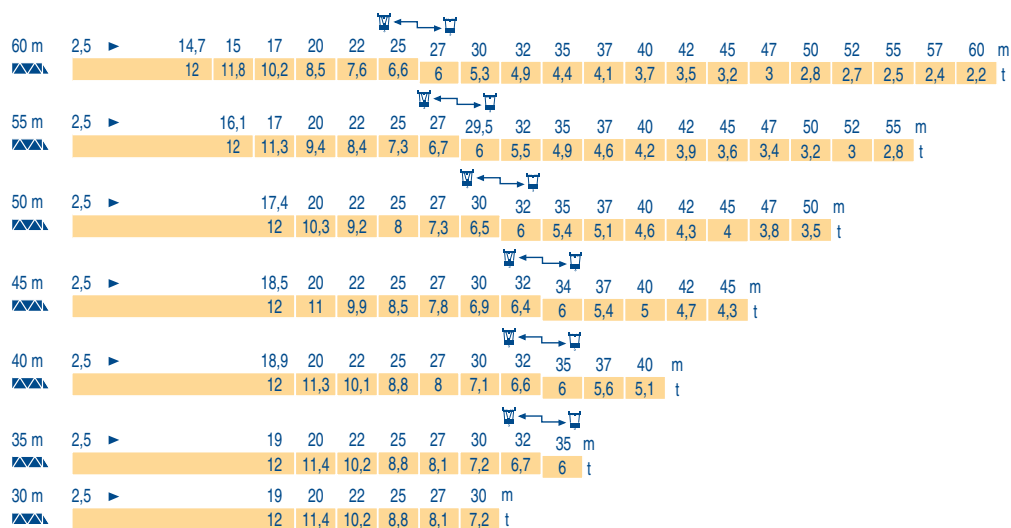

Lest de contre-flèche
Gegenauslegerballast
Counter-jib ballast
Lastre de contra flecha
Contrappeso
Lastros da contra lança

LZG 1

	3 150 kg - 2 100 kg	
	50 LVF 30	75 LVF 30
60 m	16,7 m	17 850
55 m	16,7 m	16 800
50 m	16,7 m	16 800
45 m	16,7 m	15 750
40 m	16,7 m	14 700
35 m	16,7 m	12 600
30 m	16,7 m	10 500

Lest de base
Grundballast
Base ballast
Lastre de base
Zavorra di base
Lastros da base

LZG 1

1,6 m	S 41 A	H (m)	51,6	48,3	45	40	35	30	25	20	15			
			(t)	72	72	72	72	72	72	72	72	72		
1,6 m	ZD 463	H (m)	48,9	45,6	42,3	37,3	32,3	27,3	22,3	17,3	12,3			
			(t)	72	72	72	72	72	72	72	72	72		
2 m	V 60 A	H (m)	71,2	66,2	61,2	56,2	51,2	46,2	41,2	36,2	31,2	26,2	21,2	16,2
			(t)	132	108	84	60	36	24	24	24	24	24	24
2 m	ZD 463	H (m)	55,6	52,3	47,3	42,3	37,3	32,3	27,3	22,3	17,3	12,3		
			(t)	95	80	70	70	70	70	70	70	70	70	

Topless
MDT 192 H12



	F	D	GB	E	I	P
A	Distance entre cadres	Abstand zwischen den Rahmen	Distance between collars	Distancia entra marcos	Distanza fra i telai	Distância entre quadros
H1	Hauteur grue	Kranhöhe	Crane height	Altura grúa	Altezza gru	Altura da grua
P	Poids de la grue(en service)	Krangewicht (in Betrieb)	Crane weight (in service)	Peso de la grúa (en servicio)	Peso della gru (in servizio)	Peso da grua (em serviço)
R	Réaction horizontale	Horizontalkräfte	Horizontal reaction	Reaccion horizontal	Reazione orizzontale	Reacção horizontal
	Voir télescope sur dalles	Siehe Kletterkrane im Gebäude	See climbing crane	Veja grua trepadora	Consultare gru in cavedio	Ver telescopagem sobre lages

Mécanismes
Antriebe
Mechanisms
Mecanismos
Meccanismi
Mecanismos

LZ6.1

												ch - PS hp	kW		
	50 LVF 30 Optima	m/min	2,4 → 10 → 30 → 38 → 56 → 80					1,2 → 5 → 15 → 19 → 28 → 40					50	37	454 m
		t	6	6	6	4,5	3	1,5	12	12	12	9	6	3	
	75 LVF 30 Optima	m/min	3,6 → 13 → 44 → 58 → 82 → 118					1,8 → 7,5 → 22 → 29 → 41 → 59					75	55	612 m
		t	6	6	6	4,5	3	1,5	12	12	12	9	6	3	
	6 DVF 4	m/min	0 → 50 (12t) - 0 → 100 (6t) - 0 → 120 (3t)									5,5	4		
	RVF 162 Optima +	tr/min U/min rpm	0 → 0,7									2 x 7,5	2 x 5,5		
	S 41 A RT 443 A1 2V R ≥ 10 m	m/min	15 - 30									4 x 5	4 x 3,7		
	ZD 463 RT 443 A1 2V	m/min	15 - 30									4 x 5	4 x 3,7		
	V 60 A RT 544 A1 2V R ≥ 13 m	m/min	13,5 - 27									4 x 7	4 x 5,2		
CEI 38		IEC 38		kVA											
400V (+6%-10%) 50 Hz				50 LVF : 75 kVA 75 LVF : 100 kVA					2000 / 14						

50 LVF 30
Optima

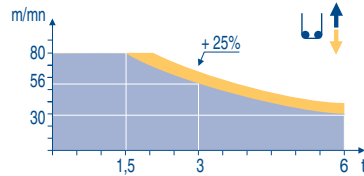

75 LVF 30
Optima

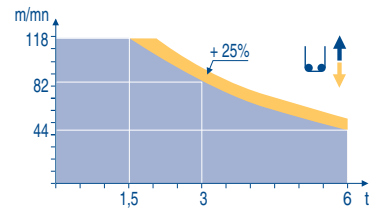

	F	D	GB	E	I	P
	Levage	Heben	Hoisting	Elevación	Sollevamento	Elevação
	Distribution	Katzfahren	Trolleying	Distribución	Distribuzione	Distribuição
	Orientation	Schwenken	Slewing	Orientación	Rotazione	Rotação
	Translation	Kranfahren	Travelling	Traslación	Traslazione	Translação
	Conforme aux directives CEE sur le niveau acoustique	Gemäss EWG-Richtlinien für den Schall-Leistungspegel	In compliance with the EEC Instructions on noise level	Conforme con las directivas CEE sobre el nivel acústico	Conforme alle direttive CEE sul livello acustico	Conforme as directivas CEE sobre o nível acústico



Document commercial non contractuel. Pour toute information technique se référer à la notice correspondante

Unverbindliches Vertriebsdokument. Für technische Informationen, siehe die entsprechenden Anweisungen.

This commercial document is not legally binding. For any technical information, please refer to the corresponding instructions.

Documento comercial no contractuel. Para cualquier información técnica, ver la noticia correspondiente.

Documento commerciale non vincolante, per tutte le informazioni tecniche fare riferimento al catalogo istruzioni

Documento comercial não contractuel. Para qualquer informação técnica complementar consultar as respectivas instruções

Bau- und Industriekräne
Verkauf-Vermietung-Service
Hebebühnen
Scheren-Bühnen
Teleskop-Arbeitsbühnen
Verkauf-Vermietung
Transporte
Spezialtransporte
Greiferarbeiten
Seilwindarbeiten
LKW mit Ladekran

BISCHAG

Grienstrasse 17
4227 Büsserach
Telefon 061 781 55 11
Fax 061 781 55 12
www.bischag.ch



Americas
Tel: +1 920 683 6322
Tel: +1 717 597 8121

Europe - Middle East - Africa
Tel: +(33) 4 72 81 50 00
Tel: +(44) 191 565 6281

Asia - Pacific
Tel: +(65) 6861 7133
Fax: +(65) 6862 4142

www.manitowoccrane.com

Manitowoc Crane Group

18, rue de Charbonnières - B.P.173
69132 ECULLY Cedex - France
Tél. : (33) 4 72 18 20 20
Fax. : (33) 4 72 18 20 00
www.manitowoccrane.com www.potain.com

Topless MDT 192 H12
Réf. 2003 48 LZG 1

Copyright.Reproduction interdite © POTAIN 2003

Réalisation HeadLines



SERVICE



VERMIETUNG



VERKAUF



Bau- und Industriekrane
LKW-Kranarbeiten
Spezialtransporte
Hydraulikservice
Arbeitsbühnen
Teleskoplader



Wahlenstrasse 175
4242 Laufen



061 781 55 11



info@bischag.ch

