

Potain Igo 30

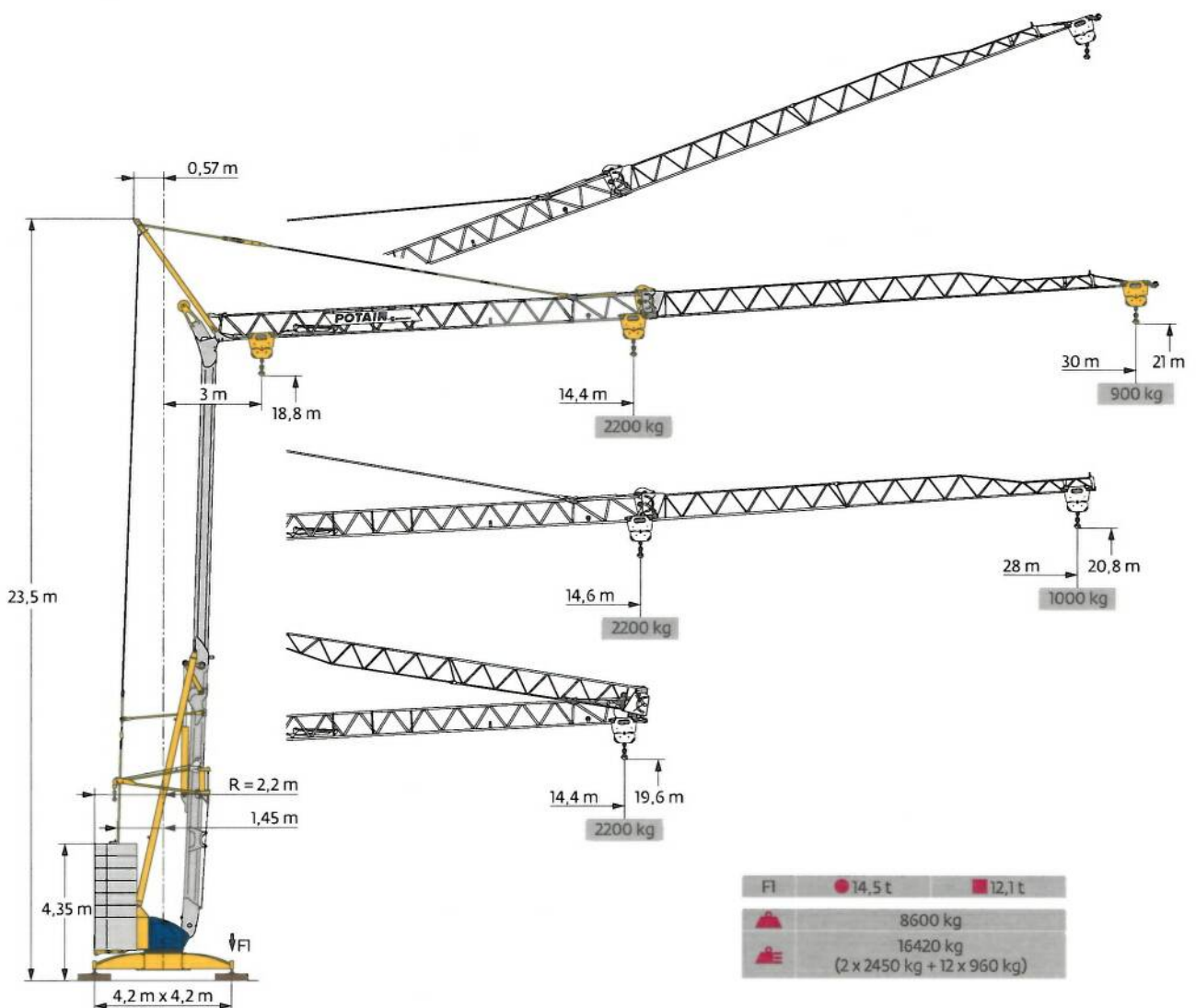

Courbes de charges / Lastkurven / Load curves / Curvas de cargas / Curve di carico
 Curvas de carga / Кривые нагрузок



30 m	3	▶	14,4	m
			2200	kg
28 m	3	▶	14,4	m
			2200	kg



3	▶	14,4	15	16	17	18	19	20	21	22	23	24	25	26	27	28	29	30	m
		2200	2095	1935	1800	1680	1570	1480	1395	1315	1245	1185	1125	1075	1025	980	940	900	kg
3	▶	14,6	15	16	17	18	19	20	21	22	23	24	25	26	27	28	m		
		2200	2135	1975	1835	1710	1600	1505	1420	1340	1270	1205	1150	1095	1045	1000	kg		

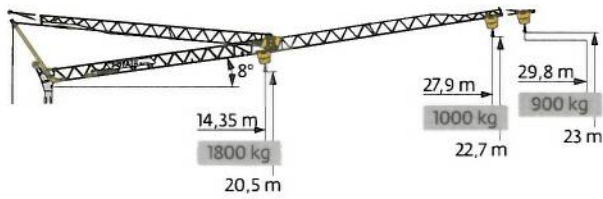



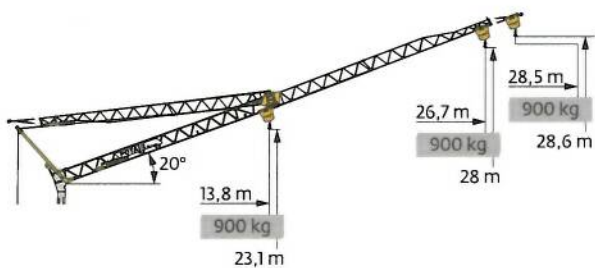



30 m	3	▶	16,9	17	18	19	20	21	22	23	24	25	26	27	28	29	29,8	m
			1800	1785	1665	1560	1465	1380	1305	1235	1175	1120	1065	1015	970	930	900	kg
28 m	3	▶	17,2	18	19	20	21	22	23	24	25	26	27	27,9	m			
			1800	1705	1595	1500	1415	1335	1265	1200	1145	1090	1040	1000	kg			



30 m	3	▶	28,5	m
			900	kg
28 m	3	▶	26,7	m
			900	kg

Mécanismes / Triebwerke / Mechanisms / Mecanismos / Meccanismi
 Mecanismos / Механизмы

400 V - 50 Hz 480 V - 60 Hz							ch - PS hp	kW	
	10 LVF 11 Optima	m/min	3,5	12	20	40	47	10	7,5
		kg	2200	2200	2200	1000	600		
	2 DVF 4	m/min	15 - 30 (900 → 2200 kg) 15 - 30 - 40 (100 → 900 kg) 15 - 30 - 47 (0 → 100 kg)					2	1,5
		tr/min	0 → 0,8						
		U/min rpm							
	RVF 31 Optima+	tr/min	0 → 0,8					2	1,5
		U/min rpm							

 IEC 60204-32	
400 V (+10% -10%) 50 Hz 480 V (+6% -10%) 60 Hz	14 kVA

10 LVF 11 Optima

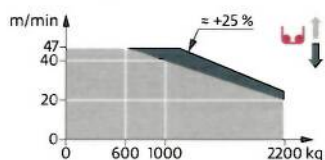

Montage / Montage / Erection / Montaje / Montaggio
 Montagem / Монтаж

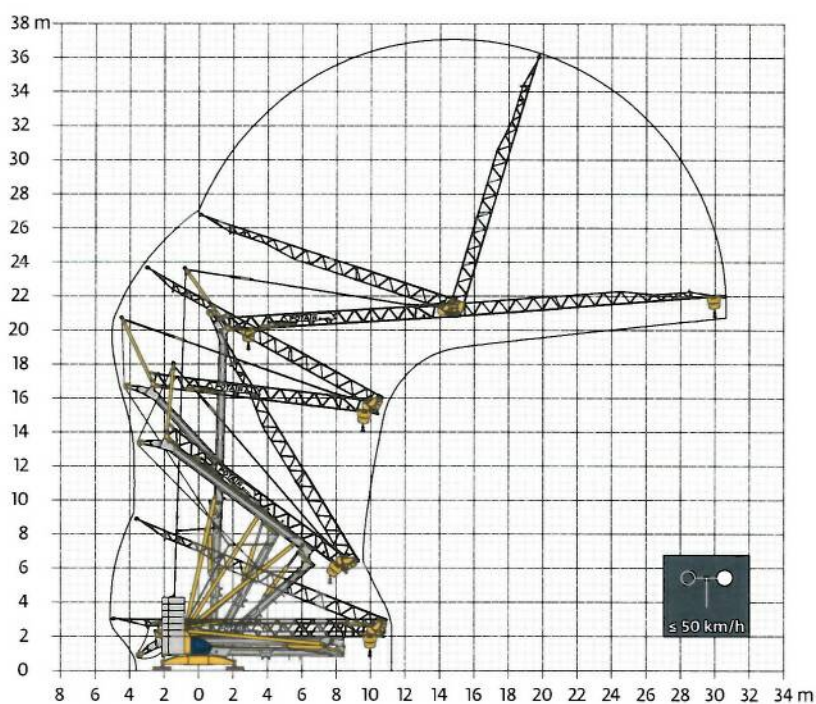

Transport / Transport / Transport / Transporte / Trasporto
Transporte / Транспортировка

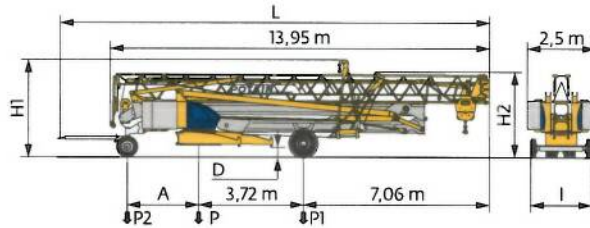

	km/h	A (m)	D (m)	H1 (m)	H2 (m)	L (m)	I (m)	P (kg)	P1 (kg)	P2 (kg)
DS62/S81	10	2,55	0,36/0,21	3,66/3,51	3,2/3,05	15,8	2,2	14080	8260	5820
DS61/S125	25	2,65	0,36/0,21	3,66/3,51	3,2/3,05	16,39	2,4	14785	8900	5885

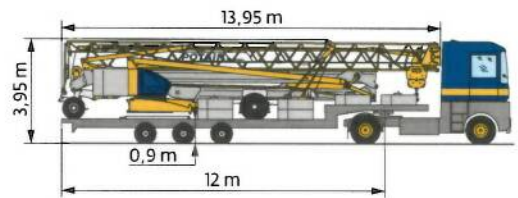
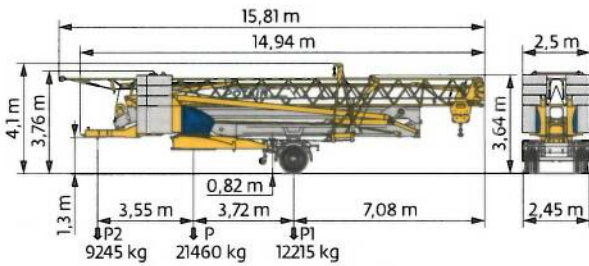

	km/h
SL121/J135	25

	FR	DE	EN	ES	IT	PT	RU
R	Rayon de giration	Schwenk radius	Rear slewing radius	Radio de giro	Raggio di rotazione	Raio de rotação	Задний габарит
i	Nous consulter	Auf Anfrage	Consult us	Consultarnos	Consultatevi	Consultar-nos	Проконсультируйтесь у нас
•	Réactions en service	Reaktionskräfte in Betrieb	Reactions in service	Reacciones en servicio	Reazioni in servizio	Reacções em serviço	Реакция при работе
■	Réactions hors service	Reaktionskräfte außer Betrieb	Reactions out of service	Reacciones fuera de servicio	Reazioni fuori servizio	Reacções fora de serviço	Реакция в покое
▲	Poids à vide, sans lest, sans trains de transport, avec flèche maxi et hauteur standard	Gewicht ohne Last, ohne Ballast, ohne Transportachsen, mit max Ausleger und Standardhöhe	Weight without load, without ballast, without transport axles, with max. jib and standard height	Peso en vacío, sin lastre, sin trenes de transporte con flecha y altura estándar	Peso a vuoto, senza zavorra, senza assali di trasporto, con braccio max e altezza standard.	Peso em vazio, sem lastro, sem eixos de transporte com lança máxima e altura standard.	Вес без груза, без балласта, без осей для транспортировки, с максимальным вылетом стрелы и стандартной высотой
■	Poids total du lest	Ballast-Gesamtgewicht	Total ballast weight	Peso total del lastre	Peso totale della zavorra	Peso total do lastro	Общий вес балласта
•	Levage	Heben	Hoisting	Elevación	Sollevamento	Elevação	Подъем
•	Distribution	Katzfahren	Trolleying	Distribución	Distribuzione	Distribuição	Перемещение по стреле
•	Orientation	Schwenken	Slewing	Orientación	Rotazione	Rotação	Поворот
W	Puissance nominale	Nennleistung	Rated power	Potencia nominal	Potenza nominale	Potência nominal	Номинальная мощность
⚠	Document commercial non contractuel. Pour toute information technique se référer à la notice correspondante.	Unverbindliches Vertriebsdokument. Für technische Informationen, siehe die entsprechenden Anweisungen	This commercial document is not legally binding. For any technical information, please refer to the corresponding instructions	Documento comercial no contractual. Para cualquier información técnica, ver la noticia correspondiente	Documento commerciale non vincolante, per tutte le informazioni tecniche fare riferimento al catalogo istruzioni.	Documento comercial não contractual. Para qualquer informação técnica complementar consultar as respectivas instruções.	Этот коммерческий документ не является юридически обязательным. Для получения технической информации, см. соответствующие инструкции.

- Bau- und Industriekrane
- Verkauf-Vermietung-Service
- Hebebühnen
- Scheren-Bühnen
- Teleskop-Arbeitsbühnen
- Verkauf-Vermietung
- Transporte
- Spezialtransporte
- Greifearbeiten
- Seilwindarbeiten
- LKW mit Ladekran

BISCHAG

Grienstrasse 17
4227 Büsserach
Telefon 061 781 55 11
Fax 061 781 55 12
www.bischag.ch



Manitowoc - Americas
Manitowoc, Wisconsin, USA
Tel: +1 920 684 6621
Fax: +1 920 683 6277

Shady Grove, Pennsylvania, USA
Tel: +1 717 597 8121
Fax: +1 717 597 4062

Manitowoc - Europe, Middle East & Africa
Ecully, France
Tel: +33 (0)4 72 18 20 20
Fax: +33 (0)4 72 18 20 00

Manitowoc - Asia & Pacific
Shanghai, China
Tel: +86 21 6457 0066
Fax: +86 21 6457 4955